

Edelstahlleitern

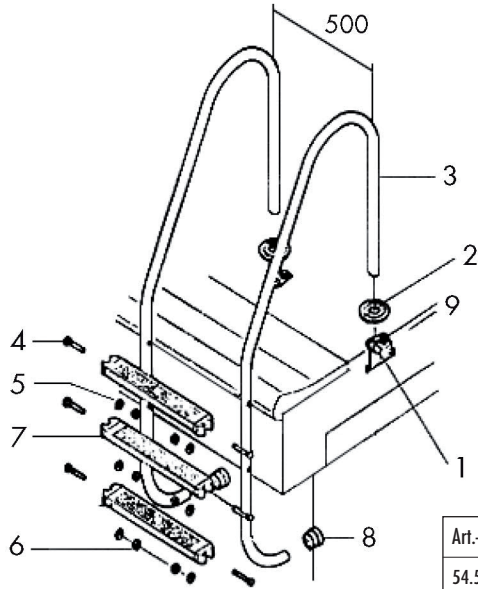

Pos.	Bezeichnung	Art.-Nr.	€/Stk.
1+9	Ankersockel	05.450.001	28,50
2	Abdeckung	05.450.002	14,45
4-6	Schraubensatz für Stufen	05.450.004	6,35
7	Stufe	05.450.005	90,25
8	Puffer	05.450.006	16,35

Art.-Nr.	Stufen	Pf	A	B	C	D	E	F	G	H	I	J	K
54.512.149	3+3	1	1052	1577	1030	360	319	250	260	498	491	710	-
54.512.147	4+4	1	1250	1827	1280	360	319	250	260	498	491	710	-
54.512.148	5+5	1	1448	2077	1530	360	319	250	260	498	491	710	-
54.512.145	3+1	1	820	1577	1030	360	319	250	260	498	491	710	450
54.512.144	4+1	1	920	1827	1280	360	319	250	260	498	491	710	450
51.512.146	5+1	1	1020	2077	1530	360	319	250	260	498	491	710	450

